

340-105



Features: 340-105

- 40 US t @ 9ft
- 105 ft maximum boom length
- 113 ft maximum tip height
- Engine power 300 hp
- Electronic rated capacity indicator
- Quick reeve boom head
- Optional 32-49 ft offsettable jib

CRANE DIMENSIONS

340-105

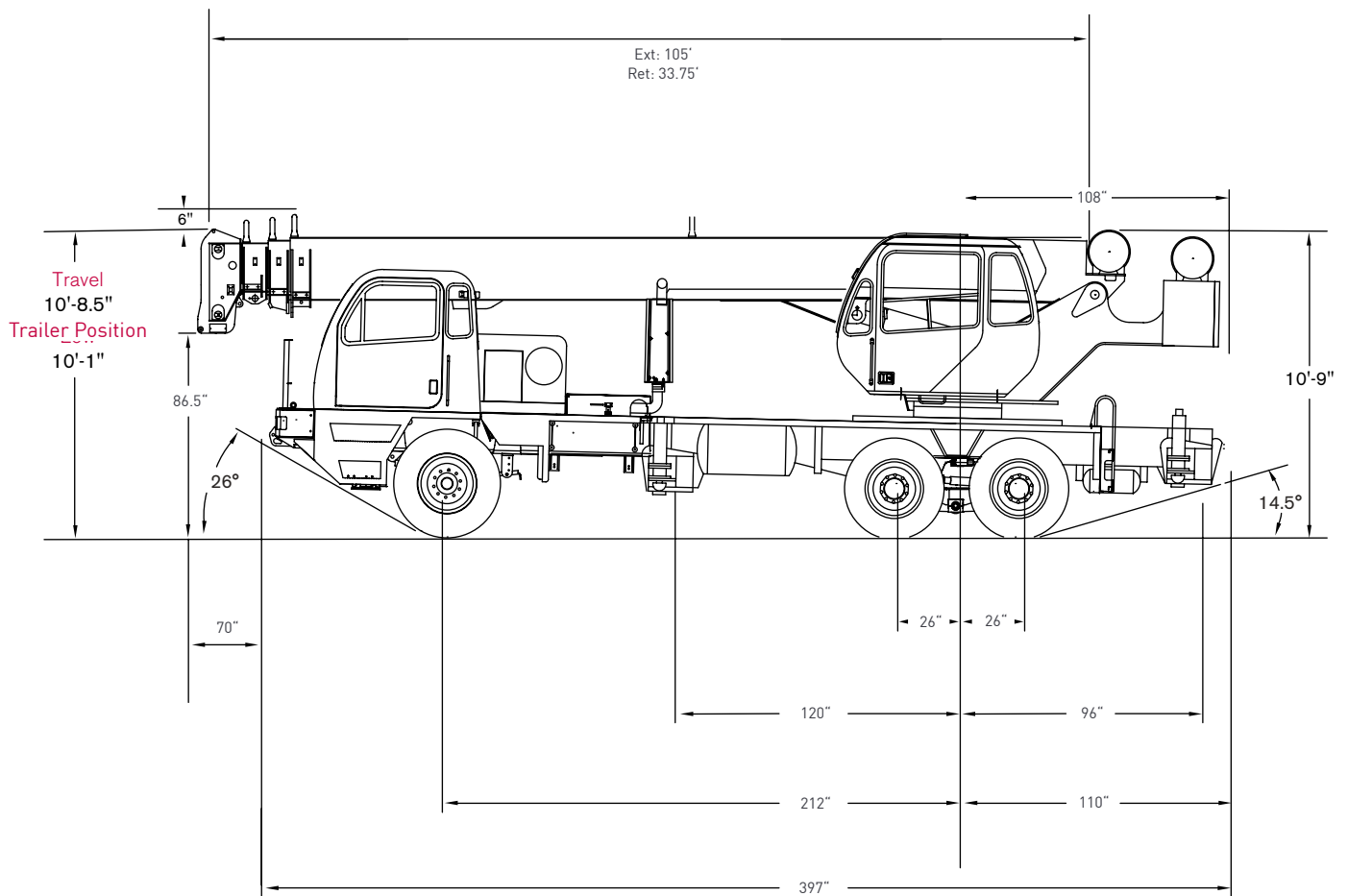

CRANE DIMENSIONS



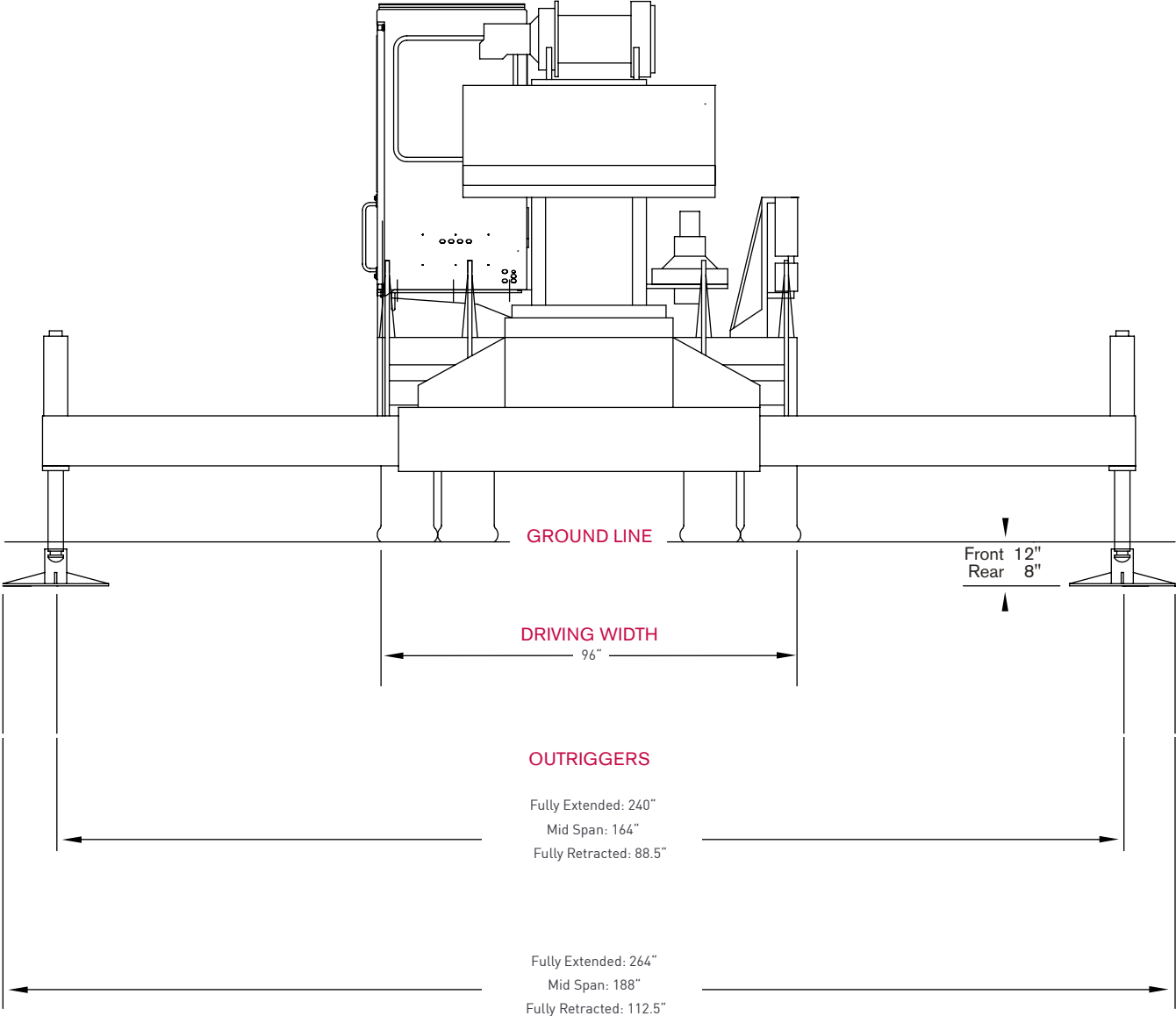





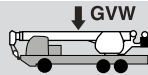
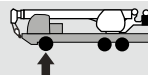
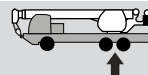
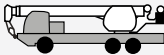

340-105



SPECIFICATIONS

340-105

Approximate Crane Weights

Boom in front travel position		 Gross Vehicle	 Front max. 22,000 lb	 Rear max. 45,000 lb
Configurations:	340-105 1/4 tank fuel 200 lb operator seated in cab Front tires: 425/65 R22.5-20PR Rear tires: 11R22-14PR 105 ft boom/no jib 11,000 lb total counterweight	60,053	16,515	43,528
				
Add options				
	Full tank of fuel	+ 315	+ 120	+ 195
	Heater/defroster in upper cab	+ 60	- 5	+ 65
	Auxiliary hoist with drum roller and wire rope	+ 175	- 73	+ 248
	Electric remote control	+ 200	+ 100	+ 100
	32 ft swing-on jib	+ 1,368	+ 1,117	+ 251
	32 ft to 49 ft extendable swing-on jib	+ 1,789	+ 1,343	+ 446
	Auxiliary boom head	+ 100	+ 154	- 54
	40 USt hook block on bumper	+ 690	+ 973	- 283
	7 USt hook and ball at bottom rack	+ 240	+ 145	+ 95
	12 USt hook and ball at bottom rack			
	Spin resistant wire rope (per winch)	+ 32	- 12	+ 44

RANGE DIAGRAM - MAIN BOOM

340-105

Outriggers Fully Extended

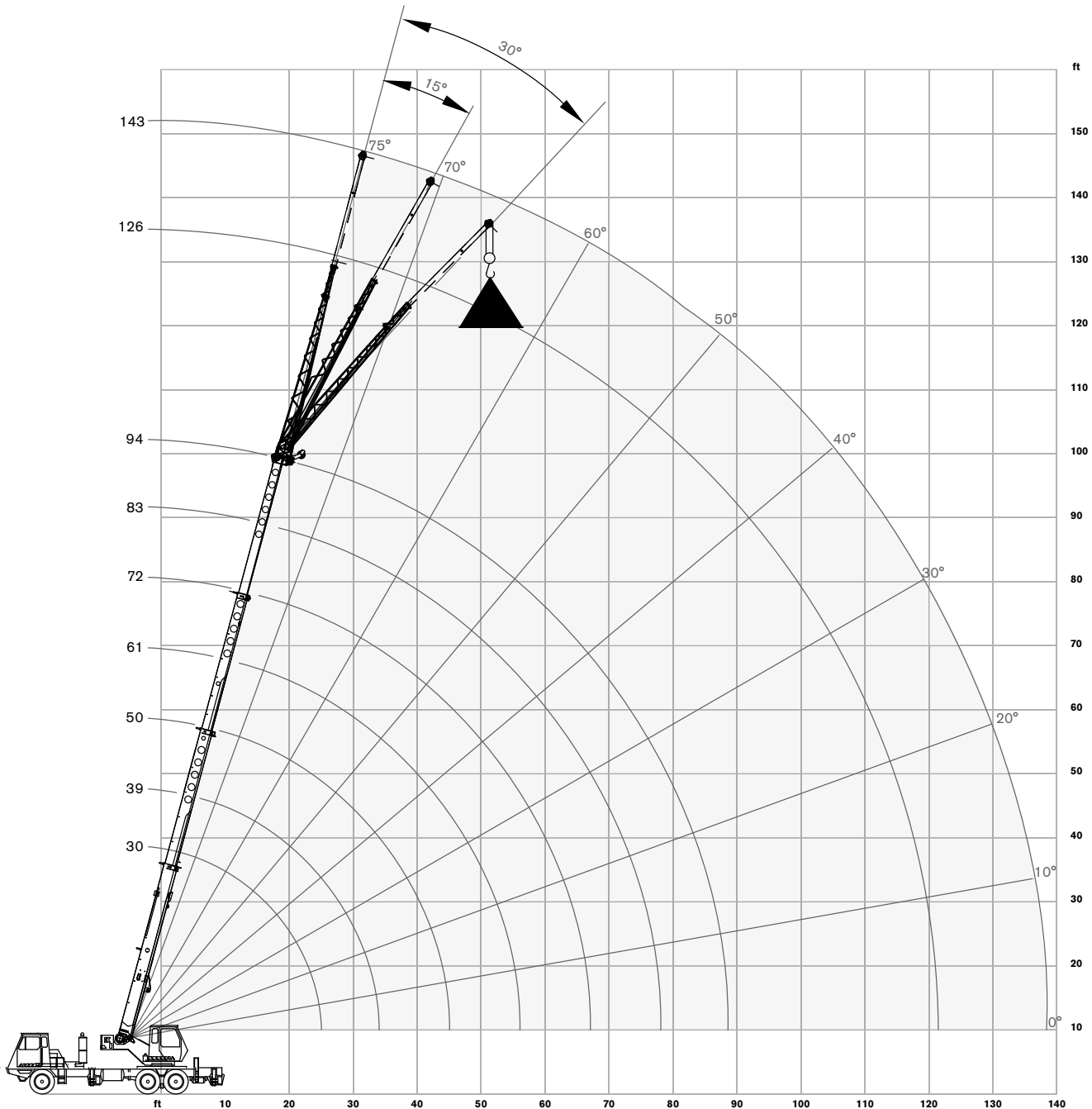

Operating radius from center line of rotation

LOAD CHART - MAIN BOOM

340-105

Outriggers Fully Extended

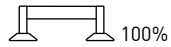
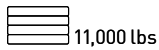

Standard ASME
B30.5

	Boom Length (ft)							
	33.75	45	57	69	81	93	105	
ft	lb	lb	lb	lb	lb	lb	lb	ft
9	80,000							9
10	64,400	46,500						10
12	58,000	46,500	46,500					12
15	50,700	46,500	44,500	41,600				15
20	38,400	38,800	36,400	34,800	30,600			20
25	28,600	29,600	30,200	29,400	26,000	23,400		25
30		22,500	23,100	23,400	22,500	20,300	18,600	30
35		16,800	17,300	17,600	17,800	17,700	16,200	35
40		12,700	13,400	13,700	13,900	14,100	14,200	40
45			10,700	11,000	11,200	11,300	11,400	45
50			8,500	8,900	9,100	9,200	9,300	50
55				7,300	7,500	7,600	7,700	55
60				5,900	6,200	6,300	6,400	60
65					5,100	5,200	5,300	65
70					4,200	4,300	4,400	70
75					3,400	3,600	3,700	75
80						2,900	3,000	80
85						2,300	2,500	85
90							2,000	90
95							1,500	95
100							1,100	100

Outriggers Fully Retracted

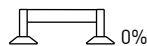
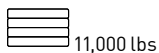

Standard ASME
B30.5

	Boom Length (ft)							
	33.75	45	57	69	81	93	105	
ft	lb	lb	lb	lb	lb	lb	lb	ft
10	36,400	37,300						10
12	26,000	26,800	27,300					12
15	17,200	18,100	18,500	18,800				15
20	9,600	10,600	11,000	11,300	11,400			20
25	5,500	6,500	7,000	7,300	7,400	7,600		25
30		3,900	4,500	4,800	4,900	5,100	5,200	30
35		2,100	2,700	3,000	3,200	3,400	3,500	35
40		700	1,400	1,800	2,000	2,100	2,200	40
45					1,000	1,200	1,300	45

Notes to lifting capacity

Lifting capacities do not exceed 85% of tipping load. Weight of hook blocks and slings is part of the load, and is to be deducted from the capacity ratings. Consult operation manual for further details.

Note: Data published herein is intended as a guide only and shall not be construed to warrant applicability for lifting purposes. Crane operation is subject to the computer charts and operation manual both supplied with the crane.

LOAD CHART - MAIN BOOM

340-105

With Offset Jibs

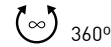
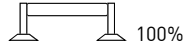
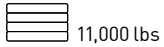

Standard ASME
B30.5

32 ft Offsettable Jib					
0° Offset		15° Offset		30° Offset	
ft	lb	ft	lb	ft	lb
43	9,200	51	8,400	57	6,500
47	8,800	55	8,100	61	6,300
51	8,400	59	7,700	65	6,200
56	7,600	64	6,300	70	5,900
62	6,100	69	5,200	75	5,000
68	5,000	75	4,400	80	4,200
74	4,100	81	3,800	85	3,400
80	3,100	87	2,900	91	2,800
87	2,400	93	2,200	97	2,200
94	1,900	99	1,800	102	1,700
101	1,400	105	1,400	107	1,300
108	900	112	900	113	800

49 ft Offsettable Jib					
0° Offset		15° Offset		30° Offset	
ft	lb	ft	lb	ft	lb
47	5,000	57	3,300	66	2,600
52	4,700	63	3,200	71	2,600
58	4,400	69	3,100	76	2,500
65	4,000	76	2,900	82	2,400
72	3,700	83	2,800	89	2,400
79	3,500	89	2,700	95	2,300
86	3,300	95	2,600	101	2,300
93	2,600	102	2,400	107	2,200
101	2,000	108	1,900	113	1,700
108	1,500	114	1,400	119	1,200
115	1,100	120	1,000	125	900
122	700				

On Tires

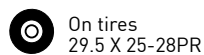
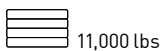

Standard ASME
B30.5

Boom		Travel Speed: Boom straight over rear		
ft	ft	0 mph lb	Creep lb	2.5 mph lb
10	33.75	21,700	21,700	16,500
12	33.75	15,600	15,600	14,900
15	45	12,800	12,800	12,700
20	45	8,500	8,500	8,500
25	45	5,800	5,800	5,800
30	45	3,800	3,800	3,800
35	57	2,500	2,500	2,500
40	57	1,700	1,700	1,700
45	57	1,000	1,000	1,000







Notes to lifting capacity

Lifting capacities do not exceed 85% of tipping load, (75% of tipping load on tires). Weight of hook blocks and slings is part of the load, and is to be deducted from the capacity ratings. Consult operation manual for further details.





Note: Data published herein is intended as a guide only and shall not be construed to warrant applicability for lifting purposes. Crane operation is subject to the computer charts and operation manual both supplied with the crane.

TECHNICAL DESCRIPTION

Boom

Standard configuration:		
	Full power extension via foot pedal control	4 sections
	Minimum / Maximum	33.75 ft / 105 ft
	Maximum tip height	113 ft
	Boom elevation angle range (min. / max.)	-4° / 88°
Optional configuration:		
	32 ft swing-on jib, fixed length	
	Angular offsets	0°, 15°, 30°
	Maximum tip height with fixed jib	145 ft
	32—49 ft swing-on two piece jib	
	Angular offsets	0°, 15°, 30°
	Maximum tip height with extended jib	162 ft
	3 or 4 metallic load sheaves Quick reeving design	
	Auxillary Head Installs only on main boom head, compatible with extendable and fixed swing-on jibs	
	2 sheave	25USt
	3 sheave	30USt
	4 sheave Quick reeving design	40USt
	Top swivel ball with hook and latch	7 USt or 12 USt

Main and Aux Hoist, Rope and Hook

Standard configuration:		
	Two speed ratios	
	1st layer without load (low range / high range) 5th layer without load (low range / high range)	167 ft/min / 335 ft/min 242 ft/min / 487 ft/min
	Maximum line pull	
	1st layer (low speed/ high speed) 5th layer (low speed/ high speed)	15,639 lb / 7,298 lb 10,827 lb / 5,052 lb
	Permissible line pull	9,000 lb
	6x19 IWRC XIPS	
	Rope diameter	5/8 in
	Maximum usable	455 ft

TECHNICAL DESCRIPTION

Cab, Controls, Operator aids and Load limiter / Load indicator

Standard configuration:



Upper cab:

- Sliding door
- Sliding window on the right side
- Tilting, tinted glass skylight
- Removable front windshield
- Six-way adjustable seat with armrest dual-axis electro-proportional joysticks
- Joystick control for hoist(s), swing and boom elevation
- Foot pedals for swing brake, boom telescope and engine rpm
- Hand control for engine rpm

Lower cab:

- Hinged door with roll-down window
- Sliding window on the right side
- Six-way adjustable seat with seatbelt
- Cruise control
- Two speed windshield wiper with washer



Electronic rated capacity indicator with color display

Optional configuration:



Upper cab:



- Air conditioning – hydraulically powered
- Heater and air conditioning package – hydraulically powered
- Liquid Propane (LP) Cab Heater
- Single-Axis armrest mounted controls
- Work Lights
- Upper cab remote carrier control
- AM/FM radio with cassette

Lower cab:

- Jacobs engine brake

TECHNICAL DESCRIPTION



Superstructure

Standard configuration:		
	Glide swing with foot pedal actuated multi-disc brake and air actuated house lock	360°
	Hydraulic driven double planetary reduction gear drive	2.5 rpm

Tires



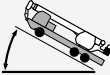

Standard configuration:		
	Aluminium wheels with stainless hub covers	
	Front Tires	445/65 R22.5-20 PR
	Rear Tires	11 R22-14 PR

Vehicle performance

Standard configuration:		
	Theoretical maximum grade	
	Manual transmission	56%
	Automatic transmission	64%
	Maximum speed	60 mph

TECHNICAL DESCRIPTION

Carrier, Engine and Drive-line

Standard configuration:	
	Turn radius to centerline of tires 34 ft
	Axle drive system 6 x 4 drive Air brakes with ABS, Air release / spring set
	Engine and transmission, EPA 2017 compliant, CARB 2017 certified Cummins L-9 Intake: Turbocharger with intercooler Rated power 8.9 L / 300 hp @ 2,000 rpm Eaton Fuller 10-speed manual transmission Fuel type: Diesel
	Fuel tank capacity 60 gallon
	Voltage 12 VDC 2 Batteries 1,000 CCA each Alternator 130 amp
Optional configuration:	
	Engine and transmission, EPA 2017 compliant, CARB 2017 certified Cummins L-9 Intake: Turbocharger with intercooler Rated power 8.9 L / 300 hp @ 2,000 rpm Allison 7-speed automatic transmission with lock-up torque converter Fuel type: Diesel

www.loadkingmfg.com

